



# 5STF 15F1232

Old part no. TR 918-1530-12

## Fast Thyristor

### Properties

- Amplifying gate
- High operational capability
- Optimized turn-off parameters

### Applications

- Power switching applications

### Key Parameters

$V_{DRM}, V_{RRM}$	= 1 200	V
$I_{TAV}$	= 1 532	A
$I_{TSM}$	= 21.0	kA
$V_{TO}$	= 1.283	V
$r_T$	= 0.209	m $\Omega$
$t_q$	= 32.0	$\mu$ s

### Types

	$V_{RRM}, V_{DRM}$
5STF 15F1232	1 200 V
5STF 15F1032	1 000 V

Conditions:  
 $T_j = -40 \div 125$  °C, half sine waveform,  
 $f = 50$  Hz, note 1

### Mechanical Data

$F_m$	Mounting force	22 $\pm$ 2 kN
$m$	Weight	0.48 kg
$D_s$	Surface creepage distance	25 mm
$D_a$	Air strike distance	13 mm

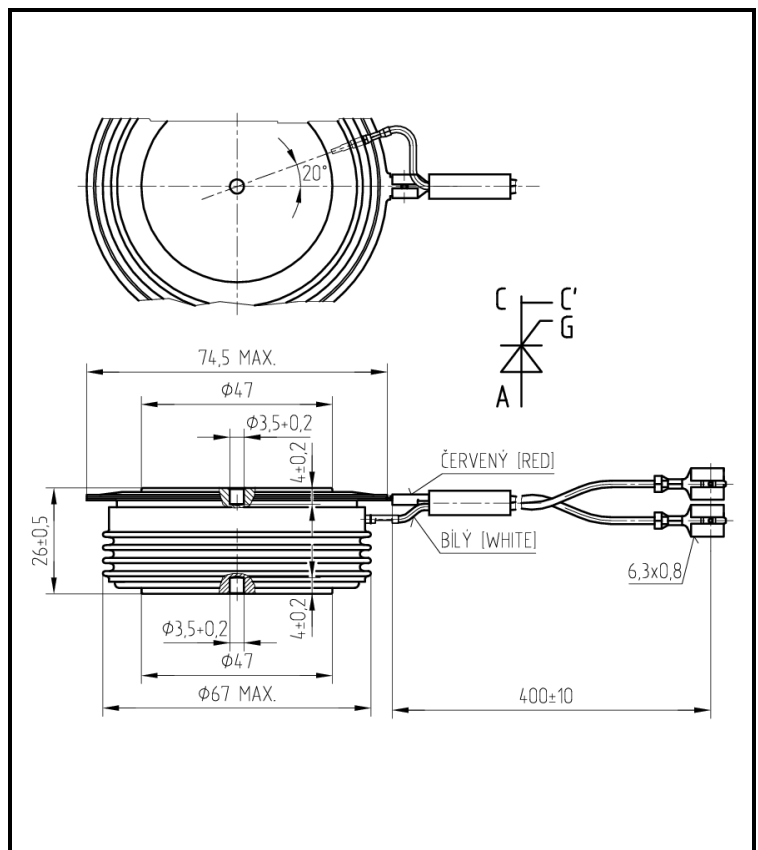

Fig. 1 Case



ABB s.r.o.

Novodvorska 1768/138a, 142 21 Praha 4, Czech Republic

tel.: +420 261 306 250, <http://www.abb.com/semiconductors>

<b>Maximum Ratings</b>			<b>Maximum Limits</b>	<b>Unit</b>
$V_{RRM}$ $V_{DRM}$	<b>Repetitive peak reverse and off-state voltage</b> $T_j = -40 \div 125 \text{ }^\circ\text{C}$ , note 1	<b>5STF 15F1232</b> <b>5STF 15F1032</b>	<b>1 200</b> <b>1 000</b>	<b>V</b>
$I_{TRMS}$	<b>RMS on-state current</b> $T_c = 70 \text{ }^\circ\text{C}$ , half sine waveform, $f = 50 \text{ Hz}$		<b>2 407</b>	<b>A</b>
$I_{TAVm}$	<b>Average on-state current</b> $T_c = 70 \text{ }^\circ\text{C}$ , half sine waveform, $f = 50 \text{ Hz}$		<b>1 532</b>	<b>A</b>
$I_{TSM}$	<b>Peak non-repetitive surge</b> half sine pulse, $V_R = 0 \text{ V}$	$t_p = 10 \text{ ms}$ $t_p = 8.3 \text{ ms}$	<b>21 000</b> <b>22 400</b>	<b>A</b>
$\int i^2 t$	<b>Limiting load integral</b> half sine pulse, $V_R = 0 \text{ V}$	$t_p = 10 \text{ ms}$ $t_p = 8.3 \text{ ms}$	<b>2 205 000</b> <b>2 080 000</b>	<b>A<sup>2</sup>s</b>
$(di_T/dt)_{cr}$	<b>Critical rate of rise of on-state current</b> $I_T = I_{TAVm}$ , half sine waveform, $f = 50 \text{ Hz}$ , $V_D = 2/3 V_{DRM}$ , $t_r = 0.3 \text{ } \mu\text{s}$ , $I_{GT} = 2 \text{ A}$		<b>800</b>	<b>A/<math>\mu\text{s}</math></b>
$(dv_D/dt)_{cr}$	<b>Critical rate of rise of off-state voltage</b> $V_D = 2/3 V_{DRM}$		<b>1 000</b>	<b>V/<math>\mu\text{s}</math></b>
$P_{GAVm}$	<b>Maximum average gate power losses</b>		<b>3</b>	<b>W</b>
$I_{FGM}$	<b>Peak gate current</b>		<b>10</b>	<b>A</b>
$V_{FGM}$	<b>Peak gate voltage</b>		<b>12</b>	<b>V</b>
$V_{RGM}$	<b>Reverse peak gate voltage</b>		<b>10</b>	<b>V</b>
$T_{jmin} - T_{jmax}$	<b>Operating temperature range</b>		<b>-40 <math>\div</math> 125</b>	<b><math>^\circ\text{C}</math></b>
$T_{stgmin} - T_{stgmax}$	<b>Storage temperature range</b>		<b>-40 <math>\div</math> 125</b>	<b><math>^\circ\text{C}</math></b>

Unless otherwise specified  $T_j = 125 \text{ }^\circ\text{C}$

Note 1: De-rating factor of 0.13%  $V_{RRM}$  or  $V_{DRM}$  per  $^\circ\text{C}$  is applicable for  $T_j$  below  $25 \text{ }^\circ\text{C}$

Characteristics		Value			Unit
		min.	typ.	max.	
$V_{TM}$	<b>Maximum peak on-state voltage</b> $I_{TM} = 2\ 000\ A$			<b>1.680</b>	<b>V</b>
$V_{T0}$	<b>Threshold voltage</b>			<b>1.283</b>	<b>V</b>
$r_T$	<b>Slope resistance</b> $I_{T1} = 2\ 403\ A, I_{T2} = 7\ 210\ A$			<b>0.209</b>	<b>mΩ</b>
$I_{DM}$	<b>Peak off-state current</b> $V_D = V_{DRM}$			<b>150</b>	<b>mA</b>
$I_{RM}$	<b>Peak reverse current</b> $V_R = V_{RRM}$			<b>150</b>	<b>mA</b>
$t_{gd}$	<b>Delay time</b> $T_j = 25\ ^\circ C, V_D = 0.4\ V_{DRM}, I_{TM} = I_{TAVm},$ $t_r = 0.3\ \mu s, I_{GT} = 2\ A$			<b>2.0</b>	<b>μs</b>
$t_q$	<b>Turn-off time</b> $I_T = 1\ 000\ A, di_T/dt = -50\ A/\mu s, V_R = 100\ V,$ $V_D = 2/3\ V_{DRM}, dv_D/dt = 50\ V/\mu s$			<b>32.0</b>	<b>μs</b>
$Q_{rr}$	<b>Recovery charge</b> <i>the same conditions as at <math>t_q</math></i>			<b>450</b>	<b>μC</b>
$I_{rrM}$	<b>Reverse recovery current</b> <i>the same conditions as at <math>t_q</math></i>			<b>150</b>	<b>A</b>
$I_H$	<b>Holding current</b>	$T_j = 25\ ^\circ C$ $T_j = 125\ ^\circ C$		<b>250</b> <b>150</b>	<b>mA</b>
$I_L$	<b>Latching current</b>	$T_j = 25\ ^\circ C$ $T_j = 125\ ^\circ C$		<b>1 500</b> <b>1 000</b>	<b>mA</b>
$V_{GT}$	<b>Gate trigger voltage</b> $V_D = 12\ V, I_T = 4\ A$	$T_j = -40\ ^\circ C$ $T_j = 25\ ^\circ C$ $T_j = 125\ ^\circ C$	<b>0.25</b>	<b>4</b> <b>3</b> <b>2</b>	<b>V</b>
$I_{GT}$	<b>Gate trigger current</b> $V_D = 12\ V, I_T = 4\ A$	$T_j = -40\ ^\circ C$ $T_j = 25\ ^\circ C$ $T_j = 125\ ^\circ C$	<b>10</b>	<b>500</b> <b>250</b> <b>150</b>	<b>mA</b>

Unless otherwise specified  $T_j = 125\ ^\circ C$

Thermal Parameters		Value	Unit
$R_{thjc}$	<b>Thermal resistance junction to case</b> <i>double side cooling</i>	16.0	K/kW
	<i>anode side cooling</i>	25.0	
	<i>cathode side cooling</i>	45.0	
$R_{thch}$	<b>Thermal resistance case to heatsink</b> <i>double side cooling</i>	4.0	K/kW
	<i>single side cooling</i>	8.0	

Transient Thermal Impedance																
<p><b>Analytical function for transient thermal impedance</b></p> $Z_{thjc} = \sum_{i=1}^4 R_i (1 - \exp(-t / \tau_i))$	<table border="1"> <thead> <tr> <th><math>i</math></th> <th>1</th> <th>2</th> <th>3</th> <th>4</th> </tr> </thead> <tbody> <tr> <td><math>\tau_i</math> (s)</td> <td>0.4653</td> <td>0.1533</td> <td>0.0375</td> <td>0.0034</td> </tr> <tr> <td><math>R_i</math> (K/kW)</td> <td>5.50</td> <td>7.24</td> <td>2.00</td> <td>1.34</td> </tr> </tbody> </table>	$i$	1	2	3	4	$\tau_i$ (s)	0.4653	0.1533	0.0375	0.0034	$R_i$ (K/kW)	5.50	7.24	2.00	1.34
$i$	1	2	3	4												
$\tau_i$ (s)	0.4653	0.1533	0.0375	0.0034												
$R_i$ (K/kW)	5.50	7.24	2.00	1.34												
<p>Conditions: <math>F_m = 22 \pm 2</math> kN, Double side cooled</p> <p><b>Correction for periodic waveforms</b></p> <table border="1"> <tbody> <tr> <td>180° sine:</td> <td>add 1.3 K/kW</td> </tr> <tr> <td>180° rectangular:</td> <td>add 1.8 K/kW</td> </tr> <tr> <td>120° rectangular:</td> <td>add 3.0 K/kW</td> </tr> <tr> <td>60° rectangular:</td> <td>add 5.1 K/kW</td> </tr> </tbody> </table>	180° sine:	add 1.3 K/kW	180° rectangular:	add 1.8 K/kW	120° rectangular:	add 3.0 K/kW	60° rectangular:	add 5.1 K/kW	<p>Fig. 2 Dependence transient thermal impedance junction to case on square pulse</p>							
180° sine:	add 1.3 K/kW															
180° rectangular:	add 1.8 K/kW															
120° rectangular:	add 3.0 K/kW															
60° rectangular:	add 5.1 K/kW															

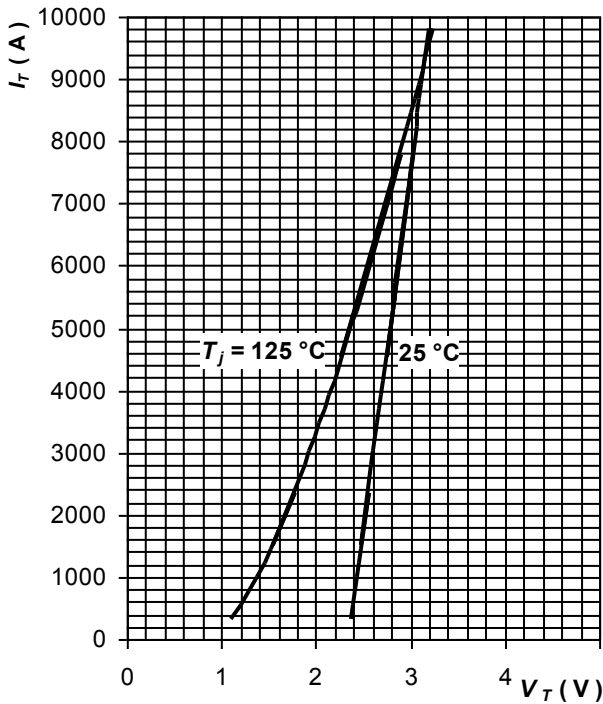

Fig. 3 Maximum on-state characteristics

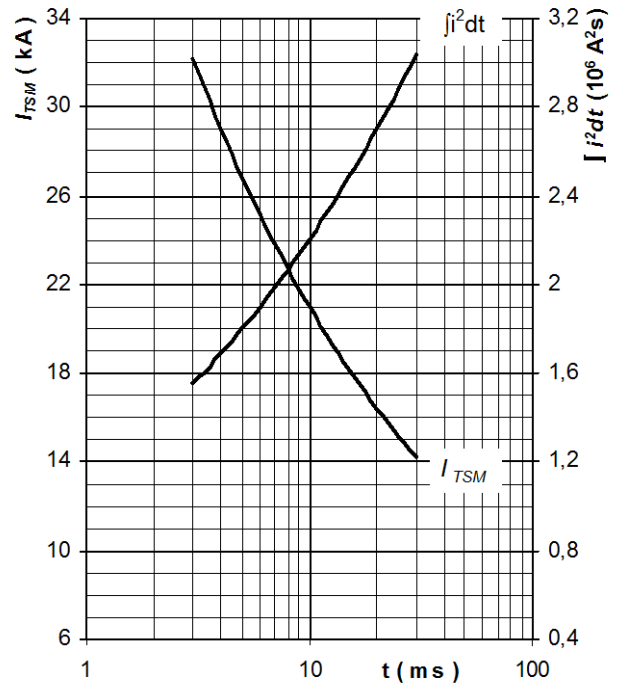

Fig. 4 Surge on-state current vs. pulse length, half sine wave, single pulse,  $V_R = 0\text{ V}$ ,  $T_j = T_{jmax}$

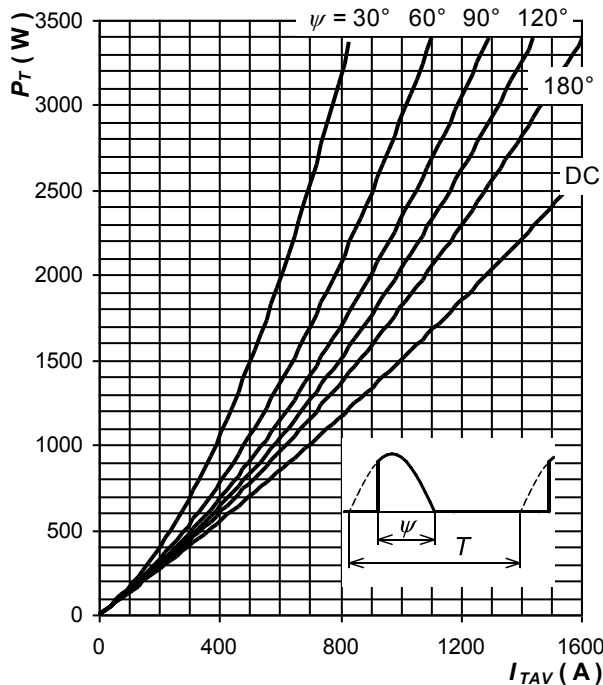

Fig. 5 On-state power loss vs. average on-state current, sine waveform,  $f = 50\text{ Hz}$ ,  $T = 1/f$

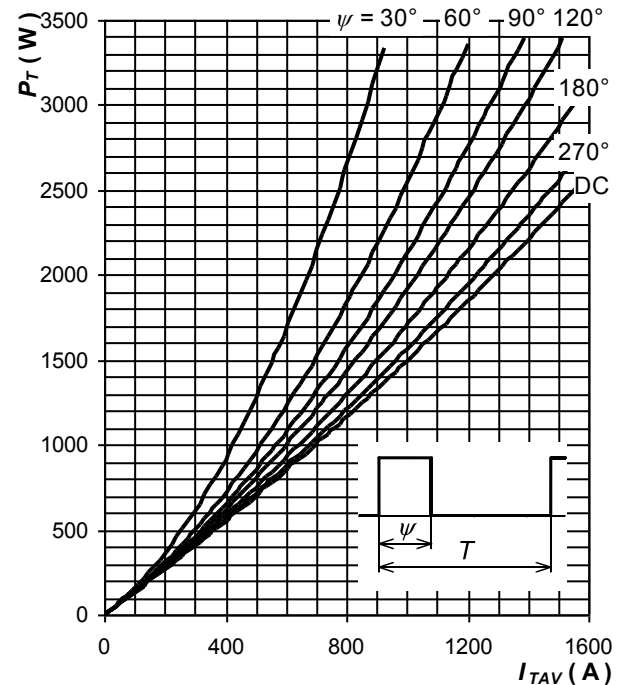

Fig. 6 On-state power loss vs. average on-state current, square waveform,  $f = 50\text{ Hz}$ ,  $T = 1/f$

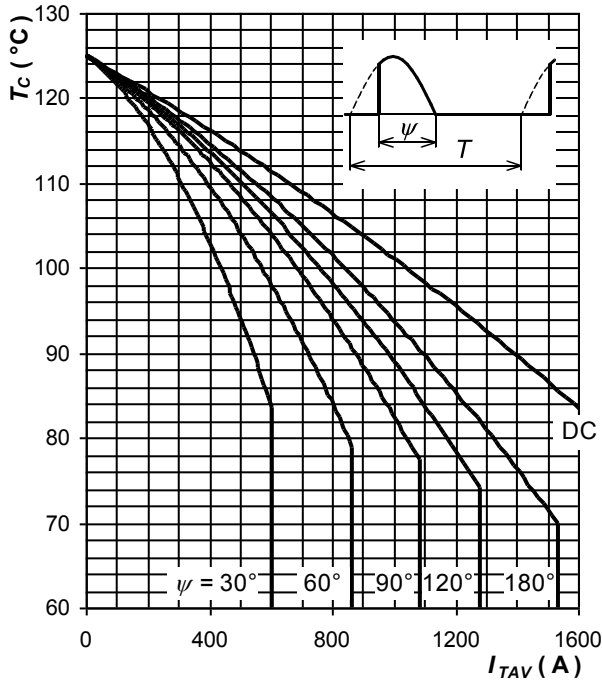

Fig. 7 Max. case temperature vs. aver. on-state current, sine waveform,  $f = 50$  Hz,  $T = 1/f$

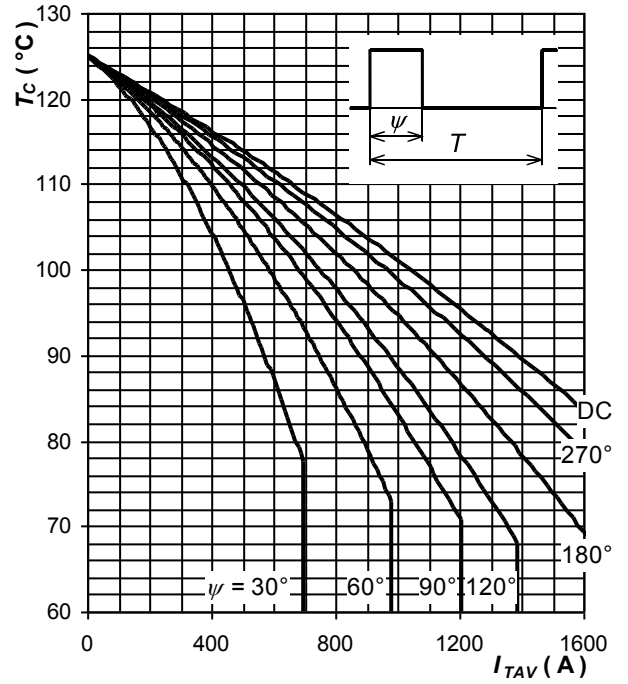

Fig. 8 Max. case temperature vs. aver. on-state current, square waveform,  $f = 50$  Hz,  $T = 1/f$

Notes: