

IGBT Module-Six Pack

50 A, 600V

PTMB50E6

PTMB50E6C

回路図 : CIRCUIT

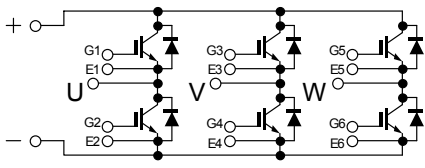

PTMB50E6

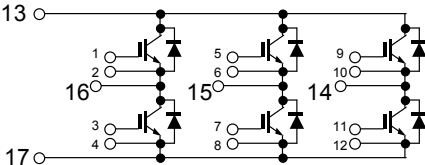

PTMB50E6C

外形寸法図 : OUTLINE DRAWING

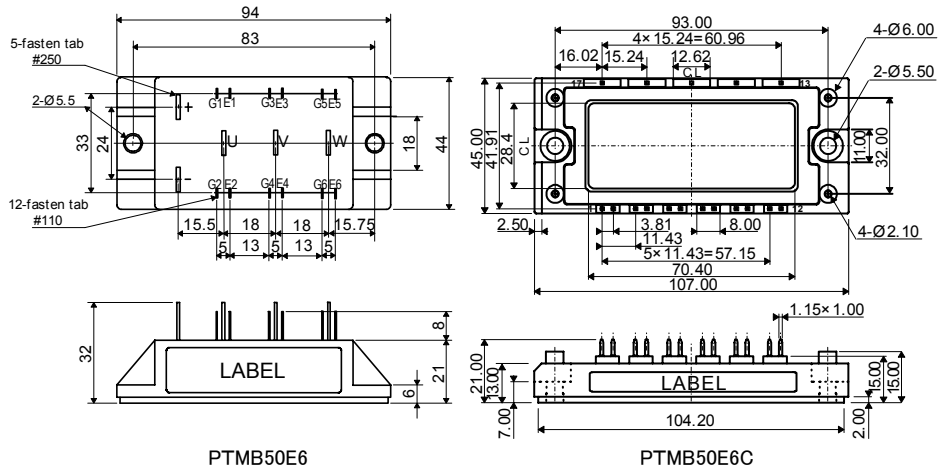

Dimension: [mm]

最大定格 : MAXIMUM RATINGS (T<sub>c</sub> = 25°C)

Item	Symbol	Rated Value	Unit
コレクタ・エミッタ間電圧 Collector-Emmitter Voltage	V <sub>CEs</sub>	600	V
ゲート・エミッタ間電圧 Gate-Emmitter Voltage	V <sub>GES</sub>	±20	V
コレクタ電流 Collector Current	DC	I <sub>C</sub> = 50	A
	1ms	I <sub>CP</sub> = 100	
コレクタ損失 Collector Power Dissipation	P <sub>C</sub>	250	W
接合温度 Junction Temperature Range	T <sub>j</sub>	-40 ~ +150	°C
保存温度 Storage Temperature Range	T <sub>stg</sub>	-40 ~ +125	°C
絶縁耐圧(Terminal to Base AC, 1 minute) Isolation Voltage	V <sub>ISO</sub>	2,500	V (RMS)
締め付けトルク Mounting Torque	F <sub>tor</sub>	2 (20.4)	N·m (kgf·cm)

電気的特性 : ELECTRICAL CHARACTERISTICS (T<sub>c</sub> = 25°C)

Characteristic	Symbol	Test Condition	Min.	Tvp.	Max.	Unit
コレクタ遮断電流 Collector-Emmitter Cut-Off Current	I <sub>CEs</sub>	V <sub>CE</sub> = 600V, V <sub>GE</sub> = 0V	-	-	1.0	mA
ゲート漏れ電流 Gate-Emmitter Leakage Current	I <sub>GES</sub>	V <sub>GE</sub> = ±20V, V <sub>CE</sub> = 0V	-	-	1.0	μA
コレクタ・エミッタ間飽和電圧 Collector-Emmitter Saturation Voltage	V <sub>CE(sat)</sub>	I <sub>C</sub> = 50A, V <sub>GE</sub> = 15V	-	2.1	2.6	V
ゲートしきい値電圧 Gate-Emmitter Threshold Voltage	V <sub>GE(th)</sub>	V <sub>CE</sub> = 5V, I <sub>C</sub> = 50mA	4.0	-	8.0	V
入力容量 Input Capacitance	C <sub>ies</sub>	V <sub>CE</sub> = 10V, V <sub>GE</sub> = 0V, f = 1MHz	-	2,500	-	pF
スイッチング時間 Switching Time	上昇時間 Rise Time	t <sub>r</sub>	-	0.15	0.30	μs
	ターンオン時間 Turn-on Time	t <sub>on</sub>	-	0.25	0.40	
	下降時間 Fall Time	t <sub>f</sub>	-	0.10	0.35	
	ターンオフ時間 Turn-off Time	t <sub>off</sub>	-	0.35	0.70	

フリーホイールダイオードの特性 : FREE WHEELING DIODE RATINGS & CHARACTERISTICS (T<sub>c</sub> = 25°C)

Item	Symbol	Rated Value	Unit
順電流 Forward Current	DC	I <sub>F</sub> = 50	A
	1ms	I <sub>FM</sub> = 100	

Characteristic	Symbol	Test Condition	Min.	Tvp.	Max.	Unit
順電圧 Peak Forward Voltage	V <sub>F</sub>	I <sub>F</sub> = 50A, V <sub>GE</sub> = 0V	-	1.9	2.4	V
逆回復時間 Reverse Recovery Time	t <sub>rr</sub>	I <sub>F</sub> = 50A, V <sub>GE</sub> = -10V di/dt = 100A/μs	-	0.15	0.25	μs

熱的特性 : THERMAL CHARACTERISTICS

Characteristic	Symbol	Test Condition	Min.	Tvp.	Max.	Unit
熱抵抗 Thermal Impedance	IGBT	R <sub>th(j-c)</sub> Junction to Case	-	-	0.50	°C/W
	Diode	(T <sub>c</sub> 測定点チップ直下)	-	-	1.10	

PTMB50E6

PTMB50E6C

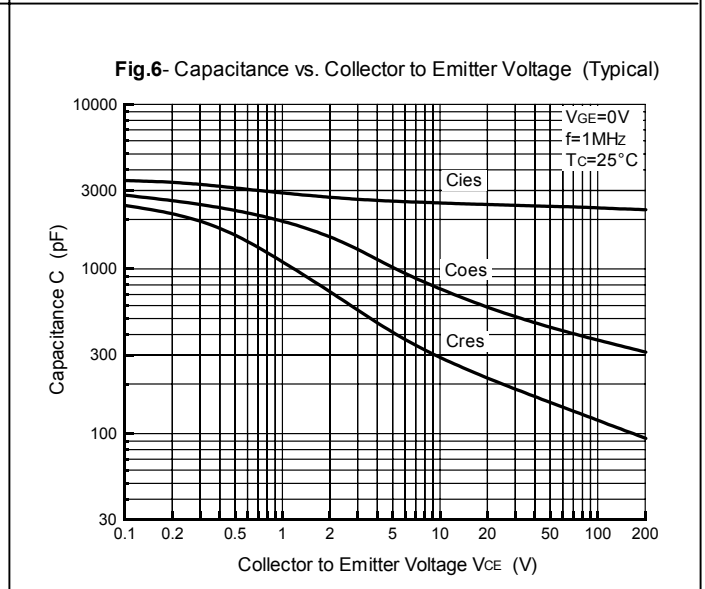
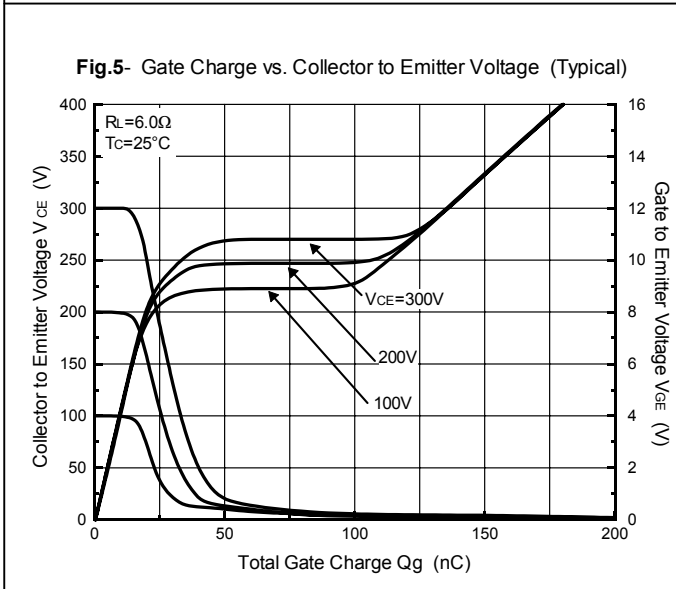
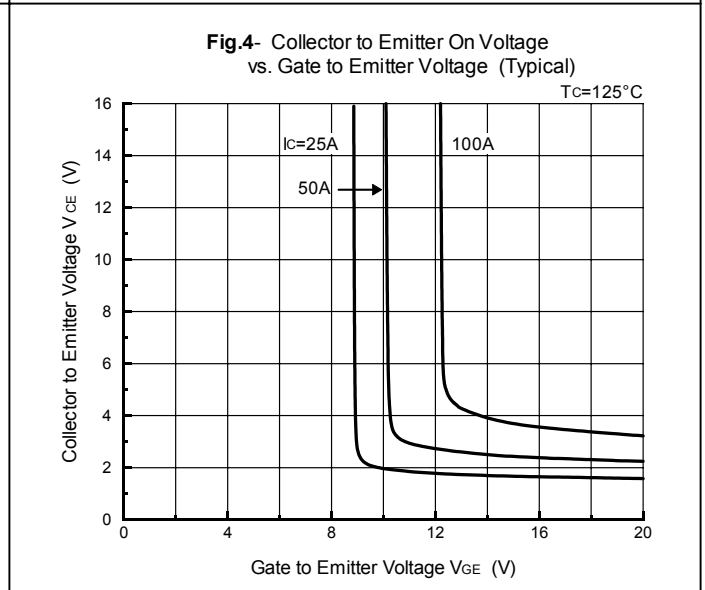
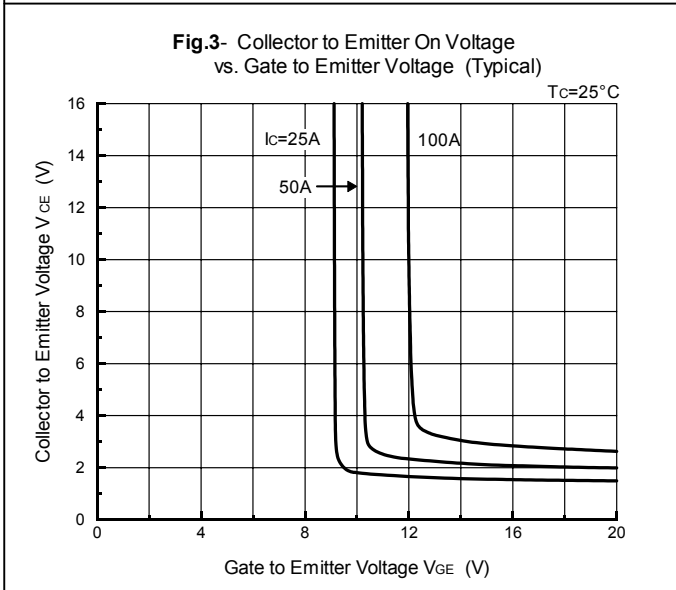
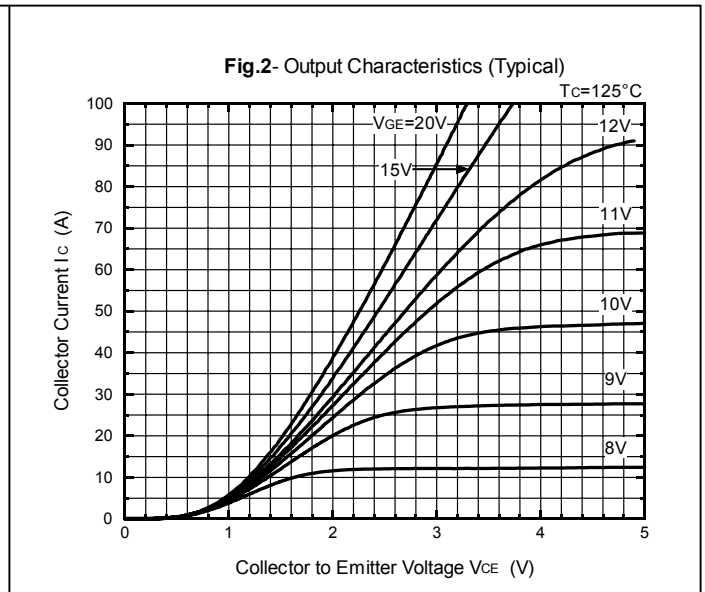
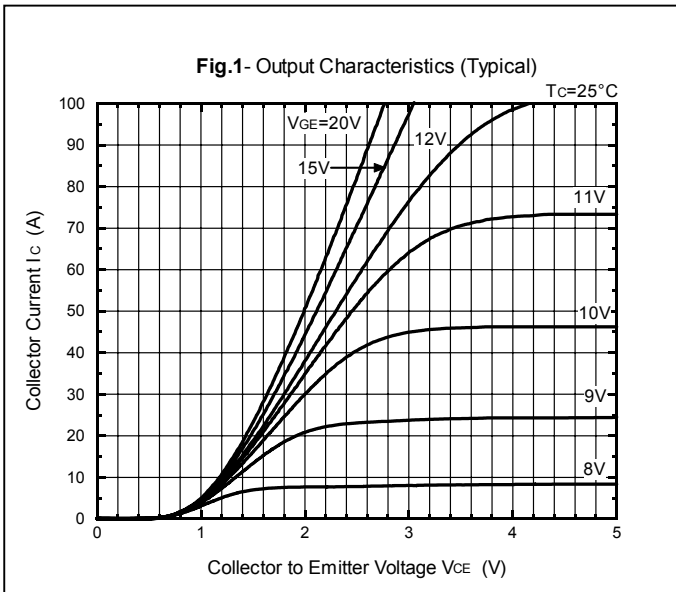

PTMB50E6

PTMB50E6C

**Fig.7- Collector Current vs. Switching Time (Typical)**

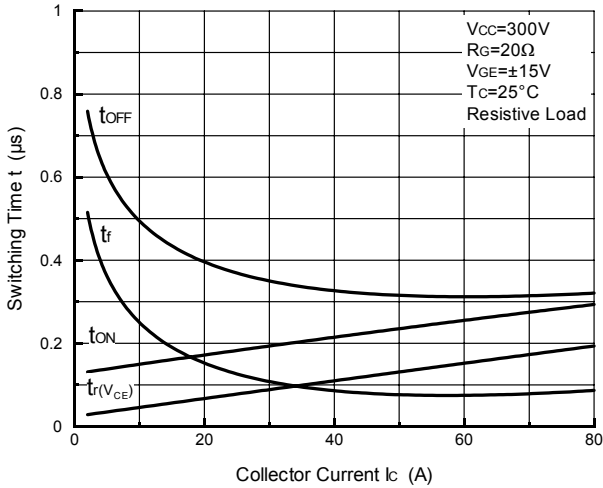

**Fig.8- Series Gate Impedance vs. Switching Time (Typical)**

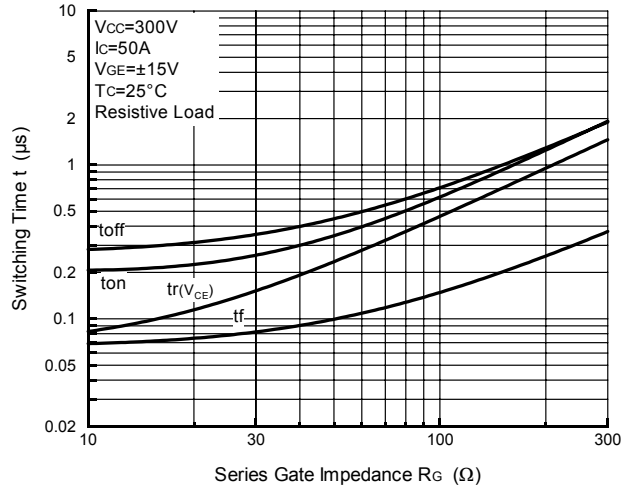

**Fig.9- Collector Current vs. Switching Time**

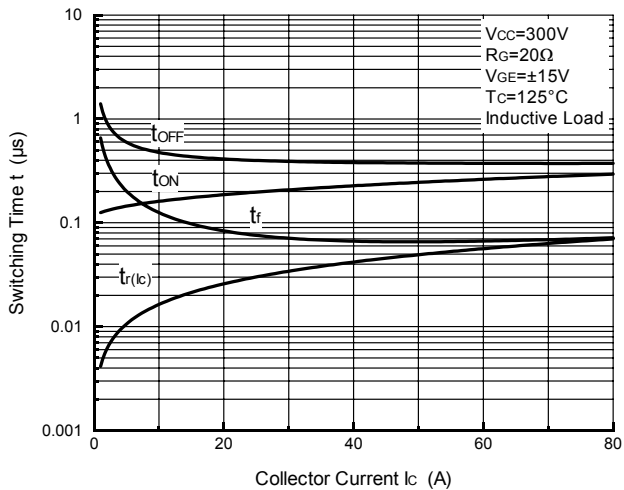

**Fig.10- Series Gate Impedance vs. Switching Time**

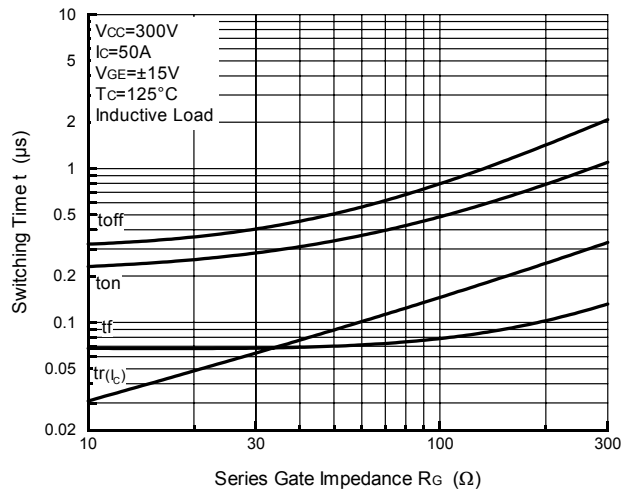

**Fig.11- Collector Current vs. Switching Loss**

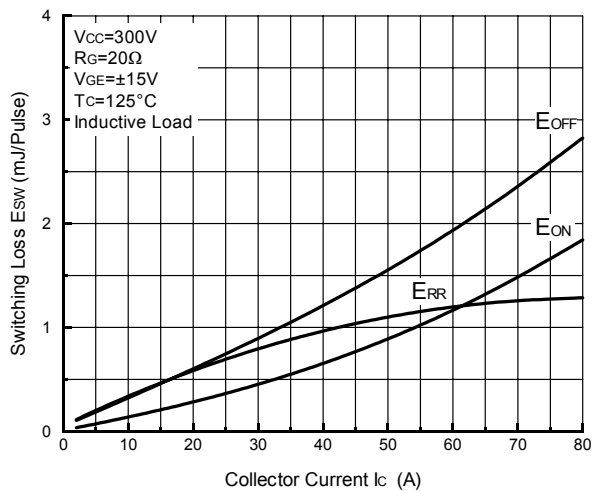

**Fig.12- Series Gate Impedance vs. Switching Loss**

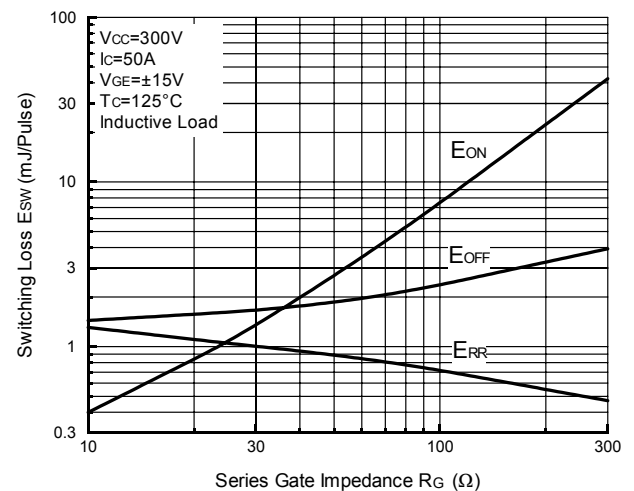

PTMB50E6

PTMB50E6C

**Fig.13- Forward Characteristics of Free Wheeling Diode (Typical)**

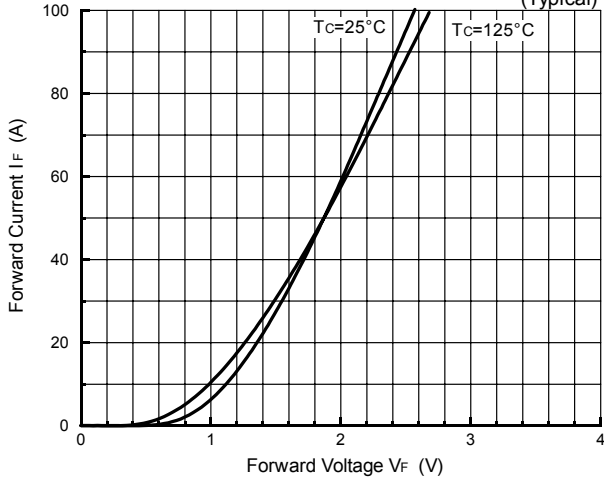

**Fig.14- Reverse Recovery Characteristics (Typical)**

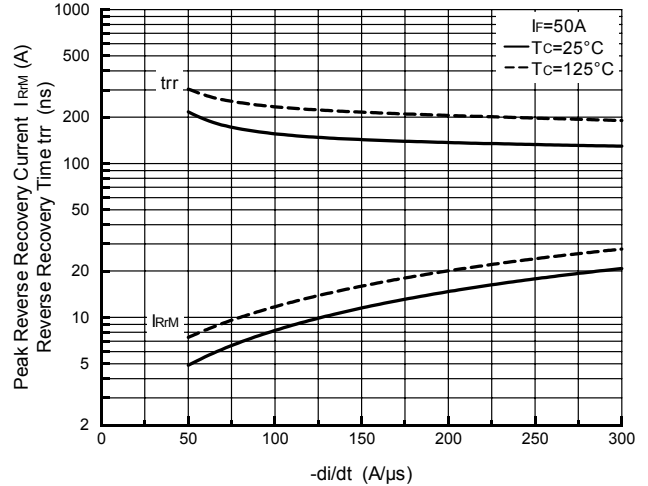

**Fig.15- Reverse Bias Safe Operating Area**

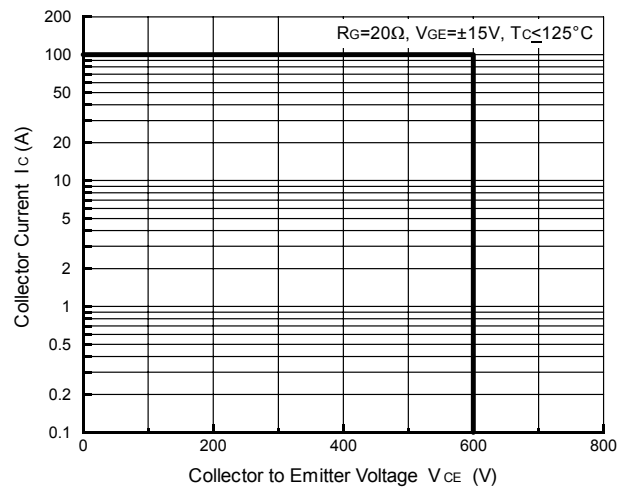

**Fig.16- Transient Thermal Impedance**

